

Imenschaltung: ST

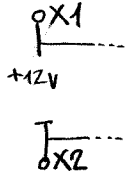

Imenschaltung: GT

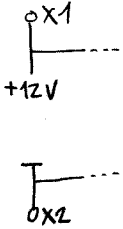

Imenschaltung: W

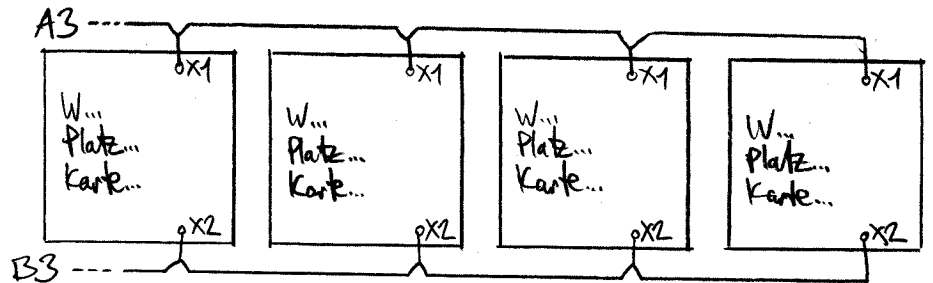
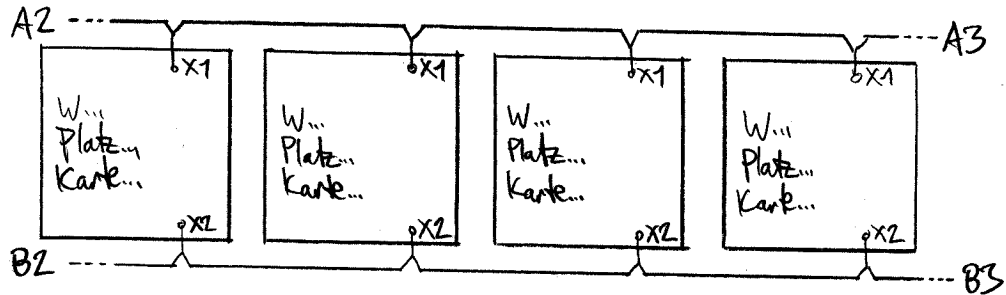
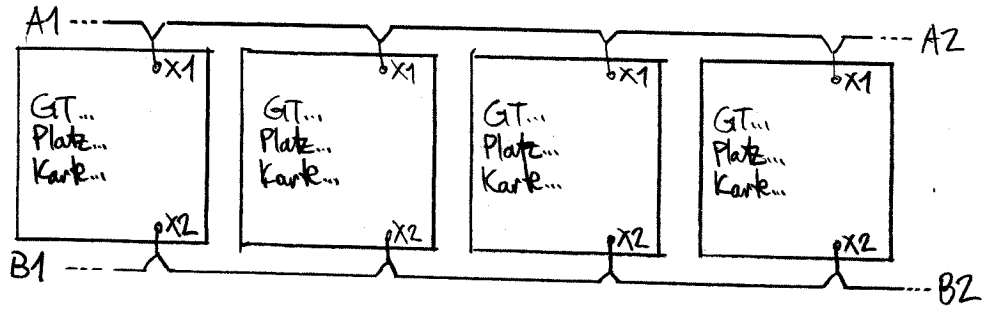
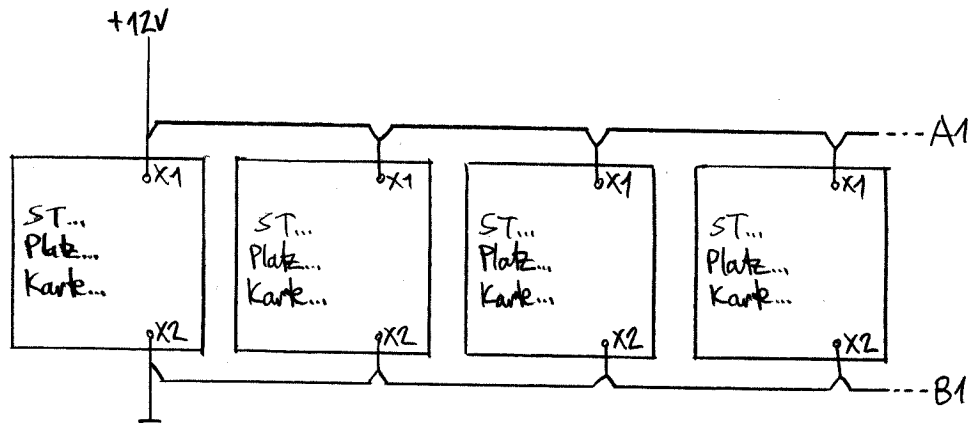

Domino 160: Stromversorgung

21.4.05 / fg

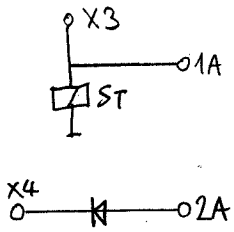

Innenschaltung: ST

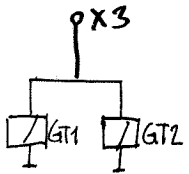

Innenschaltung: GT

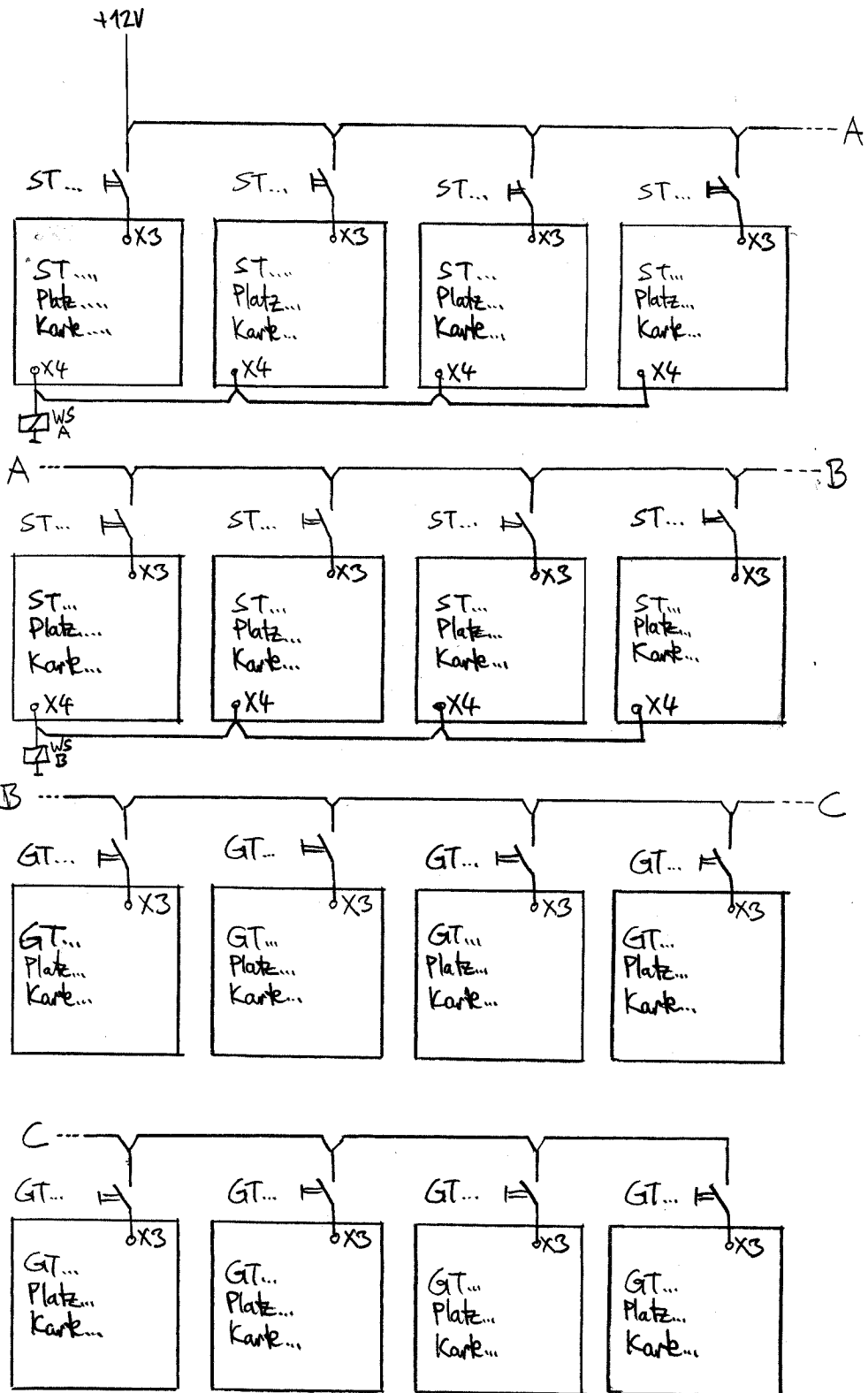

Domino 160: Stromkreise der Tasten

21.4.05 / G

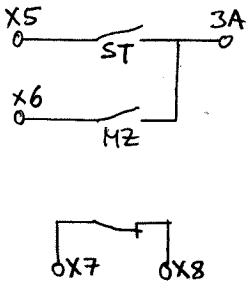

Immerschaltung = ST

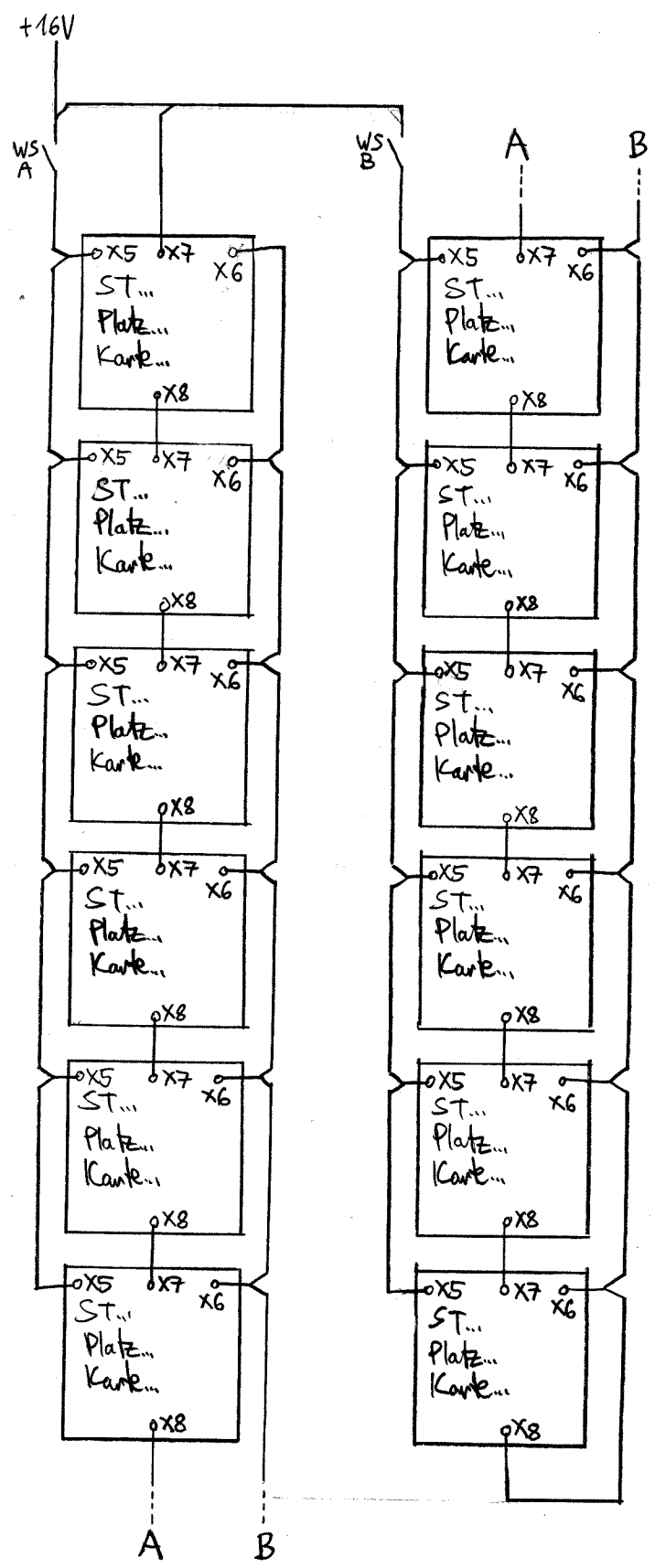

Domino 160: Speiseleitung Weichenstellstrom

21.4.05/63

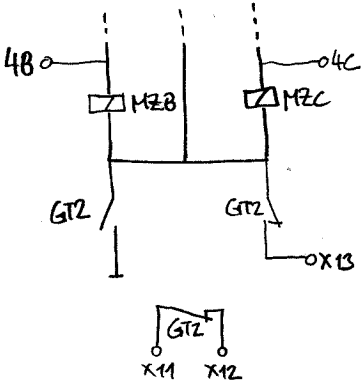

Umenschaltung: GT

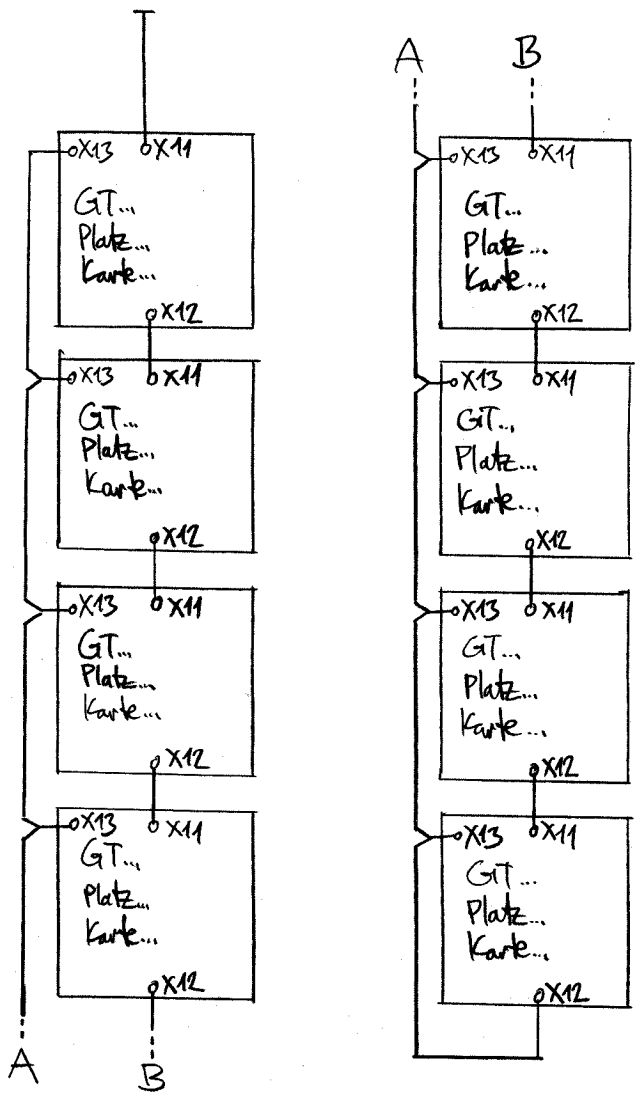

Domino 160: Speiseleitung Fahrwegüberwachung
 Z1.4105/G

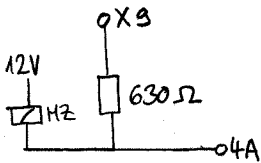

Internschaltung: ST

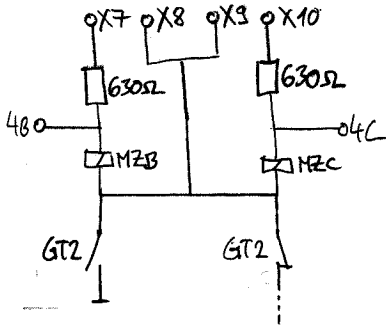

Internschaltung: GT

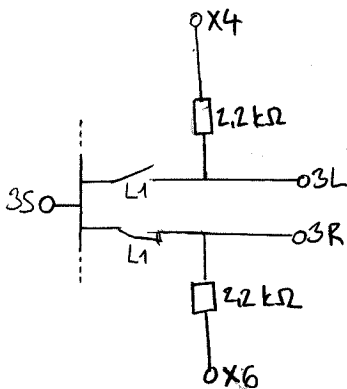

Internschaltung: W

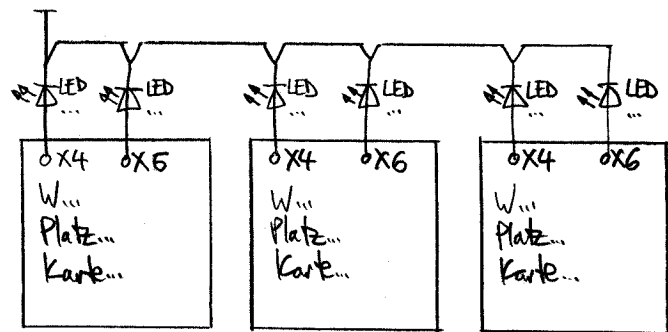
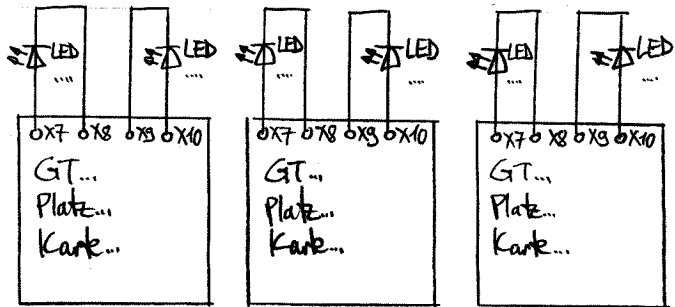
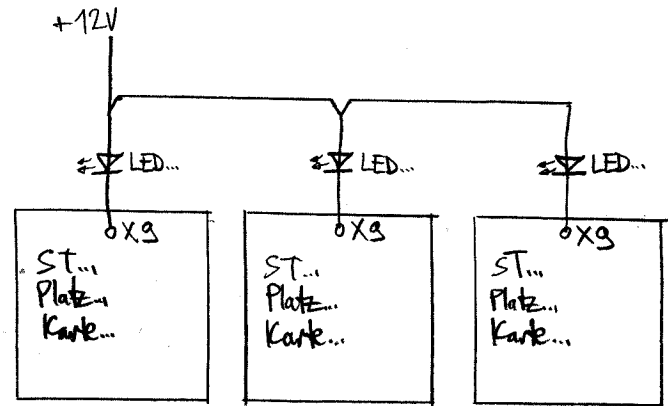

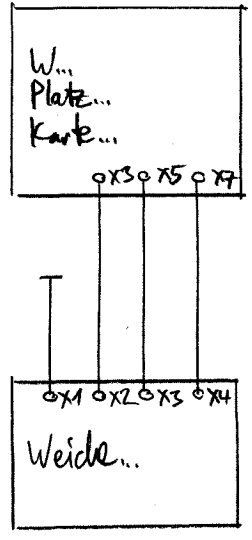
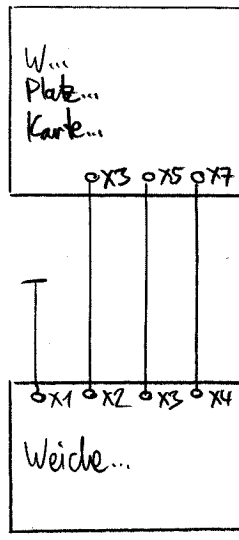
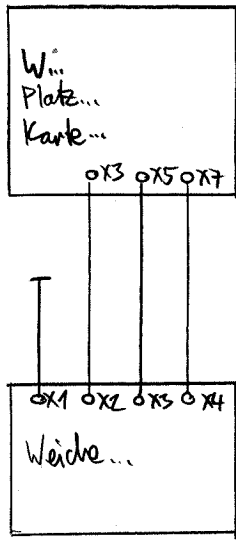
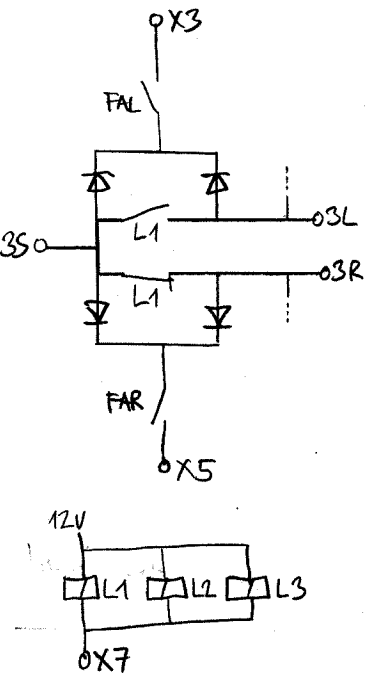

Innenanschaltung: W

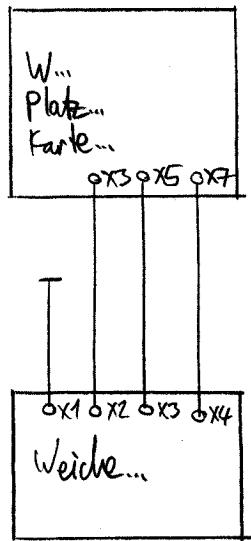
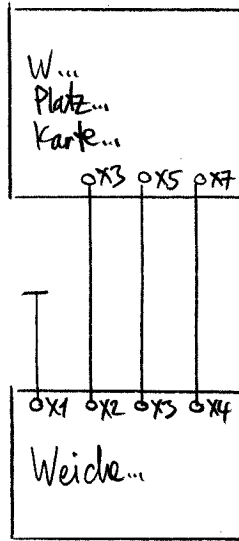
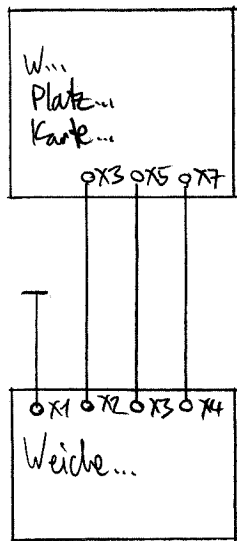
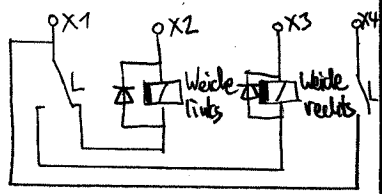

Innenanschaltung:
Peco-Magnetantrieb
mit zwei Mikroschaltern

Domino 160; Anschaltung der Weichen

Z1.4.05/63